

GRILLO - Laufhilfe Large

| Rechnungsanschrift | |
|--------------------------|--------------------------|
| Firma | |
| Straße und Nr. | |
| PLZ & Ort | |
| Telefon | |
| E-Mail | |
| | |
| Angebot | Bestellung |
| <input type="checkbox"/> | <input type="checkbox"/> |
| Lieferadresse | |
| Firma | |
| Straße und Nr. | |
| PLZ & Ort | |
| Telefon | |
| E-Mail | |
| | |
| | |
| | |
| | |
| Kommission | |
| Name | |
| Nummer | |
| | |
| Besteller | Datum |
| | |



Anterior
vorwärts

Posterior
rückwärts













Abb. Enthält Zubehör





Grundausrüstung:



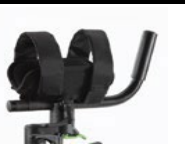





- ✓ Beckenstütze
- ✓ Ergonomische Sitzhose
- ✓ schwenkräder mit Richtungsfeststeller
- ✓ Hinterräder mit Bremse, Rücklaufstopp, Schleifbremse



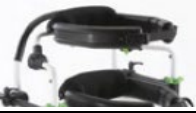

HMV Nummer 10.46.02.3047

| | |
|---|--|
|  |  |
| <p>Anterior max. Belastung 110kg Körpergröße 150 - 190cm</p> | <p>Posterior max. Belastung 110kg Körpergröße 150 - 190cm</p> |

| | VERSION PT | VERSION PA | VERSION P |
|---|---|--|---|
| Grillo Large Variante Posterior (rückwärts) |  |  |  |
| | Inklusive: - Thoraxstütze - Beckenstütze - Sitzhose - Handgriffe | Inklusive: - Beckenstütze - Sitzhose - Unterarmauflage | Inklusive: - Beckenstütze - Sitzhose - Handgriffe |
| Preis Grundmodell | 840100105074 <input type="checkbox"/> 5.238 € | 840100105080 <input type="checkbox"/> 5.051 € | 840100105086 <input type="checkbox"/> 4.317 € |
| Zubehör Thoraxstütze (925) | | | |
|  | Inklusive | 840100105116 <input type="checkbox"/> 1.036 € | 840100105116 <input type="checkbox"/> 1.036 € |
| Zubehör Einstellbare Kopfstütze (865) nur in Verbindung mit Thoraxstütze | | | |
|  | 840100105178 <input type="checkbox"/> 506 € | 840100105178 <input type="checkbox"/> 506 € | 840100105178 <input type="checkbox"/> 506 € |
| Zubehör Ergonomischer Sattel (946) | | | |
|  | 840100105184 <input type="checkbox"/> 325 € | 840100105184 <input type="checkbox"/> 325 € | 840100105184 <input type="checkbox"/> 325 € |
| Zubehör untere Schrittführung (890-SC) | | | |
|  | 840100105108 <input type="checkbox"/> 656 € | 840100105108 <input type="checkbox"/> 656 € | 840100105108 <input type="checkbox"/> 656 € |
| Zubehör Beintrennschiene mit Beinführung (890-C) | | | |
|  | 840100105098 <input type="checkbox"/> 723 € | 840100105098 <input type="checkbox"/> 723 € | 840100105098 <input type="checkbox"/> 723 € |
| Zubehör Unterarmauflage (809) | | | |
|  | 840100105146 <input type="checkbox"/> 792 € | Inklusive | 840100105146 <input type="checkbox"/> 792 € |
| Zubehör Armschlaufen für Unterarmauflage (943) | | | |
|  | 840100105150 <input type="checkbox"/> 44 € | 840100105150 <input type="checkbox"/> 44 € | 840100105150 <input type="checkbox"/> 44 € |
| | VERSION PT | VERSION PA | VERSION P |

| | VERSION PT | VERSION PA | VERSION P |
|--|--------------------------|--------------------------|--------------------------|
| Zubehör Ergonomische Handgriffe (939) | | | |
|  | 840100105136 | 840100105136 | 840100105136 |
| | <input type="checkbox"/> | <input type="checkbox"/> | <input type="checkbox"/> |
| | 171 € | 171 € | 171 € |
| Zubehör abklappbare Abduktionsführung(815) | | | |
|  | 840100105176 | 840100105176 | 840100105176 |
| | <input type="checkbox"/> | <input type="checkbox"/> | <input type="checkbox"/> |
| | 411 € | 411 € | 411 € |
| Zubehör Zusatzgewichte Rahmen (810) | | | |
|  | 840100105166 | 840100105166 | 840100105166 |
| | <input type="checkbox"/> | <input type="checkbox"/> | <input type="checkbox"/> |
| | 205 € | 205 € | 205 € |
| Hinterräder nach innen Versetzt nur für Innenräume (928) | | | |
|  | 840100105168 | 840100105168 | 840100105168 |
| | <input type="checkbox"/> | <input type="checkbox"/> | <input type="checkbox"/> |
| | 206 € | 206 € | 206 € |
| | VERSION PT | VERSION PA | VERSION P |

| | VERSION PT | VERSION PA | VERSION P |
|---|---|---|---|
| Grillo Large Variante Anterior (vorwärts) |  |  |  |
| | Inklusive: - Thoraxstütze - Beckenstütze - Sitzhose - Handbügel | Inklusive: - Beckenstütze - Sitzhose - Unterarmauflage | Inklusive: - Beckenstütze - Sitzhose - Handbügel |
| Preis Grundmodell | 840100105056 <input type="checkbox"/> 5.238 € | 840100105062 <input type="checkbox"/> 5.051 € | 840100105068 <input type="checkbox"/> 4.317 € |
| Zubehör Thoraxstütze (925) | | | |
|  | Inklusive | 840100105116 <input type="checkbox"/> 1.036 € | 840100105116 <input type="checkbox"/> 1.036 € |
| Zubehör Ergonomischer Sattel (946) | | | |
|  | 840100105184 <input type="checkbox"/> 325 € | 840100105184 <input type="checkbox"/> 325 € | 840100105184 <input type="checkbox"/> 325 € |
| Zubehör untere Schrittführung (890-SC) | | | |
|  | 840100105108 <input type="checkbox"/> 656 € | 840100105108 <input type="checkbox"/> 656 € | 840100105108 <input type="checkbox"/> 656 € |
| Zubehör Beintrennschiene mit Beinführung (890-C) | | | |
|  | 840100105098 <input type="checkbox"/> 723 € | 840100105098 <input type="checkbox"/> 723 € | 840100105098 <input type="checkbox"/> 723 € |
| Zubehör Unterarmauflage (809) | | | |
|  | 840100105142 <input type="checkbox"/> 757 € | Inklusive | 840100105142 <input type="checkbox"/> 757 € |
| Zubehör Armschlaufen für Unterarmauflage (943) | | | |
|  | 840100105150 <input type="checkbox"/> 44 € | 840100105150 <input type="checkbox"/> 44 € | 840100105150 <input type="checkbox"/> 44 € |
| | VERSION PT | VERSION PA | VERSION P |

| | VERSION PT | VERSION PA | VERSION P |
|--|---|---|---|
| Zubehör Ergonomische Handgriffe (939) | | | |
|  | 840100105138 <input type="checkbox"/> 135 € | 840100105138 <input type="checkbox"/> 135 € | 840100105138 <input type="checkbox"/> 135 € |
| Zubehör abklappbare Abduktionsführung(815) | | | |
|  | 840100105176 <input type="checkbox"/> 411 € | 840100105176 <input type="checkbox"/> 411 € | 840100105176 <input type="checkbox"/> 411 € |
| Zubehör Zusatzgewichte Rahmen (810) | | | |
|  | 840100105166 <input type="checkbox"/> 205 € | 840100105166 <input type="checkbox"/> 205 € | 840100105166 <input type="checkbox"/> 205 € |
| Hinterräder nach innen Versetzt nur für Innenräume (928) | | | |
|  | 840100105168 <input type="checkbox"/> 206 € | 840100105168 <input type="checkbox"/> 206 € | 840100105168 <input type="checkbox"/> 206 € |
| | VERSION PT | VERSION PA | VERSION P |